

Sickerblock mit Anschlusskomponenten

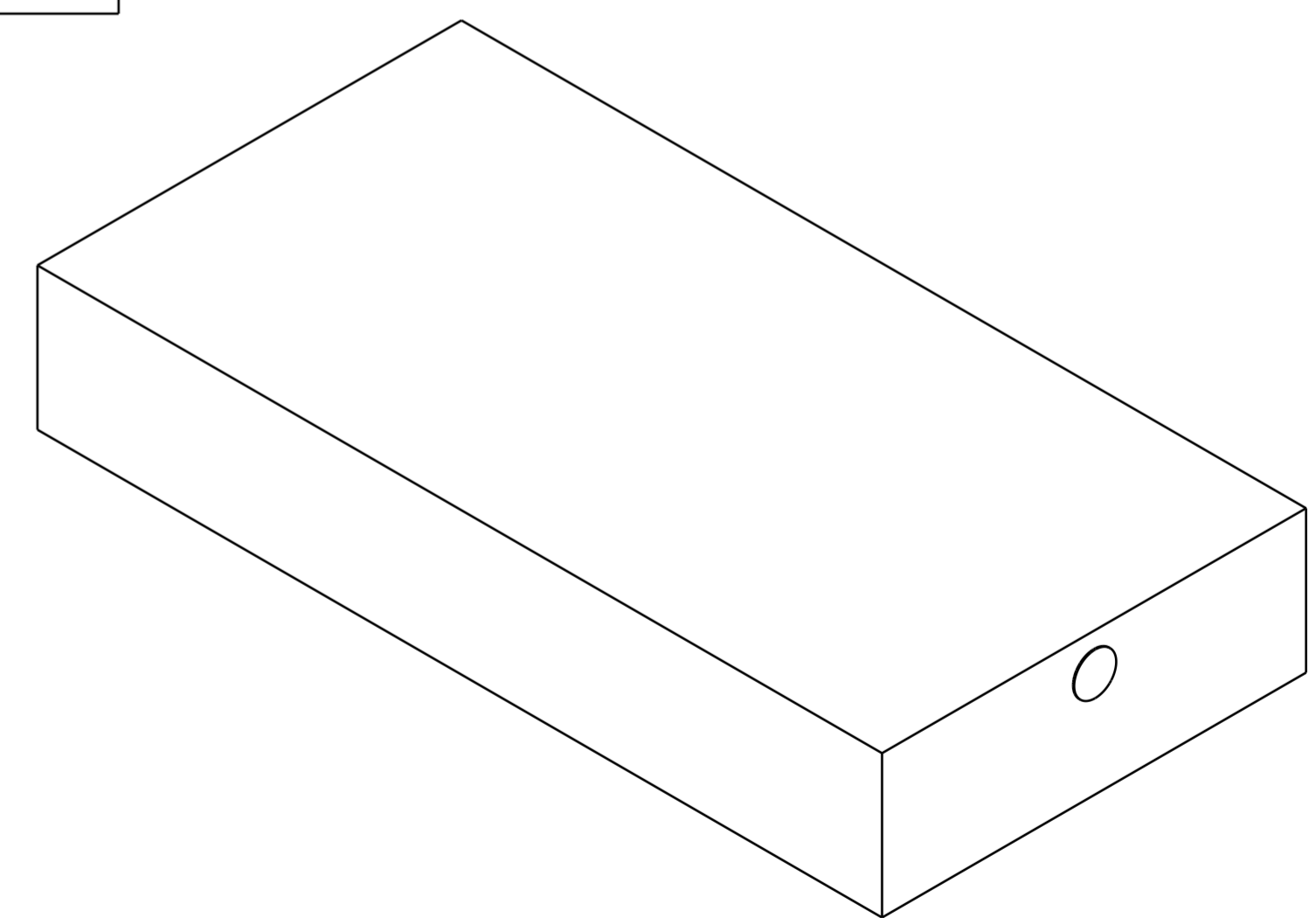
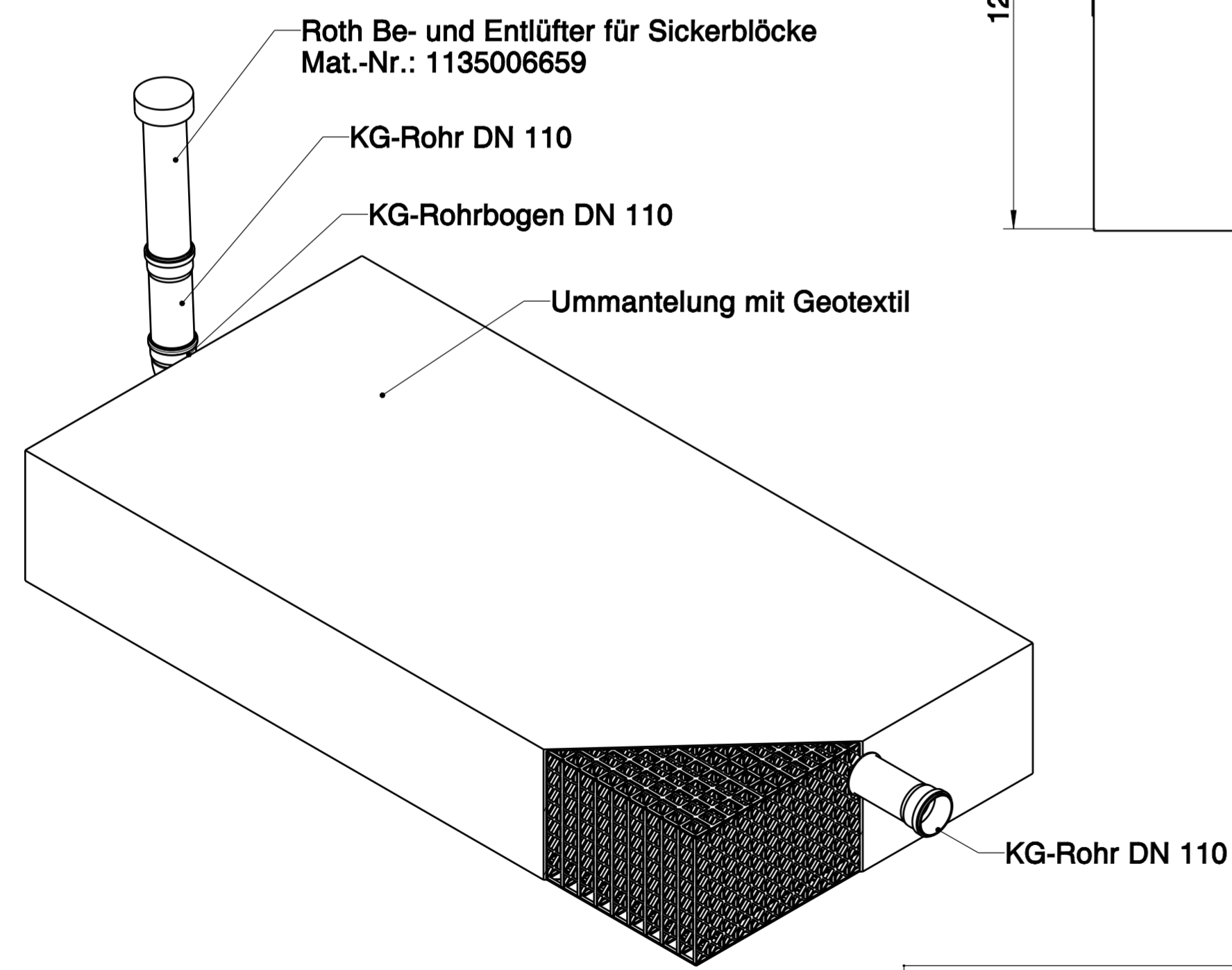

Schnitt C-C

Roth
Roth Umwelttechnik
ZNL der Roth Werke GmbH

Sickerblock 1200 L

Zeichnungs-Nr.: 1011317_KI	Material-Nr.: 1135006656
Versions-Nr.: 00	Name: Burk Datum: 27.07.20